

**Ecological Studies of Wolves on Isle Royale**

# Wolves

**2017-2018**





"...there's no quick fix once an apex predator is gone. Maintaining an intact ecosystem is so much easier than trying to restore it once the pieces have been lost."

— T.N. Hobbs, Colorado State University, 2015



# Ecological Studies of Wolves on Isle Royale

Annual Report 2017 - 2018

by

**Rolf O. Peterson, John A. Vucetich, and Sarah R. Hoy**

School of Forest Resources and Environmental Science, Michigan Technological University,  
Houghton, Michigan USA 49931-1295

30 April 2018

During the past year, major support for these studies was received from the National Science Foundation (DEB-1453041), National Park Service (CESU Task Agreement No. P11AC90808), a McIntyre-Stennis Grant (USDA-Nifa #1004363), Robert Bateman Endowment at the Michigan Tech Fund, James L. Bigley Revocable Trust, and Detroit Zoological Society.

For the period, March 1st 2017 through February 28th 2018, additional contributions were received from the following organizations and individuals: Robert & Lynn Aho, Dianne W. Ashley, Karen A. Bacula, Dorthey L. Behrend, Leigh Beith, Jerry & Jennifer Boeckman, Dominic Bragg & Tracy Dulak, Joseph V. Brazie, Sheri A. Buller, Paul Buzzard, Michael Casner, Center for Biological Diversity, Alex M. Christensen, Alison J. Clarke, Donald C. Close, Nicholas Conrardy, James Deignan, Ronald & Barbara Eckoff, Mary C. Edgar, James Eder, Christopher Eisner, Ronald L. Felzer, Marjorie H. Freeman, C. Michael & K.A. George, Edith N. Greene, Randolph A. Gschwind, John & Heidi Harlander, Christine I. Hammond, John H. Heidtke, John Heneghan, Jeffrey Holden & Sandra Noll, Humane Society of the U.S., Robert & Sally Irmiger, Dan B. Kimball, Kraig Klungness & Katherine Alvord, Roddie Larsen, Dana & Donna Lowell, Daniel MacEachron & Blackrock Inc., William & Nicole Maier, Michael & Linda Meetz, Elizabeth Mooy, Paul S. Mueller, Richard & Beatrice Ann Murray, Minnesota Zoo Foundation, Oxie Farm, Michael & Kari Palmer, Janet L. Parker, Mary G. Peters, Rolf & Carolyn Peterson, Joseph & Nancy Plumbo, Marcel Potvin & Ann Chouinard, John & Joyce Raducha, Jay Richardson, Robert & Darcy Rutkowski, John & Linda Schakenbach, Barbara Schmeckpepe, John Stryker, Ronald & Inge Sumanik, Superior Measurement Solutions, Russell & Barbara Tabbert, David K. Weaver, Albert & Frances Wilson.

Ken Vrana of the Isle Royale Institute has been of critical value for helping to organize our research expeditions. Dick Murray provided help in the field with Moosewatch expeditions. We gratefully acknowledge the contributions, personal time, and financial assistance of the volunteer members of our research expeditions:

**Team IA** – Joe Olenik (leader), David Dzubinski, Lance Dzubinski, Larry Fuerst, Ron Porritt, Wayne Shannon.

**Team IB** – Barrett Warming (leader), Jim Clink, Earl Conteh-Morgan, Erik Freeman, Cathy More.

**Team IC** - Chris Woeltje (leader), Bob Bollinger, Hal Hanson, Jennifer Hebert, Mark Kanitz, Loreen Niewenhuis.

**Team IIA** – Paul Buzzard (leader), David Anthony, Erik Freeman, Laura Kiiroja.

**Team IIB** - Clay Ecklund (leader), Dan Goyen, Mike Plantenga, Austin Thomas.

**Team IIIA** – Jason Duetsch (leader), Thomas Rutti (leader), Jim Clink, Liz Dengate, Alexa McPherson, Nicole Williamson.

**Team IIIB** – Jeff Holden (leader), David Conrad (leader), David Beck, Erik Freeman, Angela Johnson, Briana LaBelle-Hahn.

**Team IVA** - Michael George (leader), Anne Nagi, Mark Ode, Tina Ode.

**Team IVB** - Karen Bacula (leader), Irene Fiala, Catherine Salome.

To learn more about how you can join one of our research expeditions, visit [www.isleroyalewolf.org](http://www.isleroyalewolf.org) and click “Contribute & Participate.” Tax-deductible donations to support continuing research on Isle Royale wolves and moose can be sent to Wolf-Moose Study, Michigan Tech Fund, Michigan Technological University, 1400 Townsend Drive, Houghton, Michigan 49931-1295. *Thank you* to all who help!

Results reported here are preliminary and, in some cases, represent findings of collaborators; please do not cite without consulting the authors. The views expressed here do not necessarily reflect those of the U.S. National Park Service or the U.S. National Science Foundation.



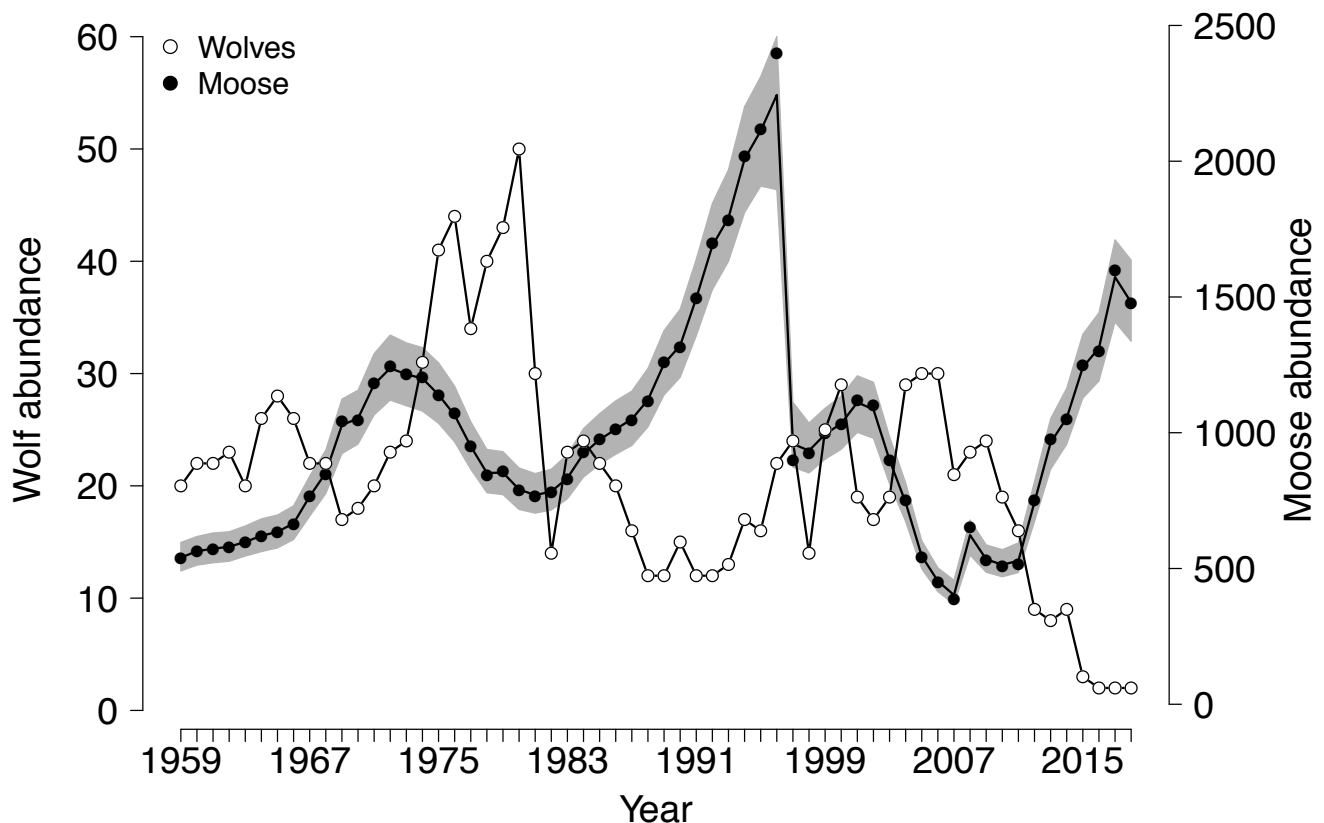
[www.isleroyalewolf.org](http://www.isleroyalewolf.org) and “Wolves and Moose of Isle Royale” (Facebook)

# Ecological Studies of Wolves on Isle Royale

## Summary

Between January 2017 and January 2018, the wolf population continued to be comprised of just two wolves (Figure 1). The wolves are believed to be a male-female pair and closely related to one another. The wolf population is also almost certainly headed for extinction, and wolf predation has been effectively absent as an ecological process for the past seven years. Moose abundance probably increased over the past year even though the most recent point estimate declined from 1600 to 1475 moose

based on the moose census in 2018. In the absence of wolf predation, moose abundance may double over the next four or five years. If that happens, it will be the largest number of moose ever observed during the six-decade history of the wolf-moose project. The National Park Service recently announced it has decided to restore a viable wolf population in Isle Royale National Park, but we await a signed Record of Decision and a projected timetable for wolf restoration.



**Figure 1.** Wolf and moose fluctuations, Isle Royale National Park, 1959-2018. Moose population estimates (filled circles) during 1959-2001 were based on population reconstruction from recoveries of dead moose, whereas estimates from 2002-2018 were based on aerial surveys. Moose population estimates (lines) and confidence intervals (gray shaded area) were based on Gompertz state-space models (Hoy et al. in review), while the confidence intervals reported in the text emphasize sampling error associated with aerial survey.

## Background

Isle Royale National Park is a remote island located about fifteen miles from Lake Superior's northwest shoreline. The Isle Royale wolf population typically varies from 18 to 27 animals, organized into three packs. The moose population usually numbers between 700 and 1,200 moose. The wolf-moose project of Isle Royale, now in its 60th year, is the longest continuous study of any predator-prey system in the world.

Moose first arrived on Isle Royale in the early 1900s, then increased rapidly in a predator-free environment. For fifty years, moose abundance fluctuated dramatically, limited only by starvation. Wolves established themselves on Isle Royale in the late 1940s by crossing an ice bridge that connected the island to mainland Ontario. Researchers began annual observations of wolves and moose on Isle Royale in 1958-59.

Isle Royale's biogeography is well-suited for the project's goals. That is, Isle Royale's wolves and moose are isolated, and the population fluctuations we observe are due primarily to births and deaths, not the movements of animals to and from the island. Also, the small number of mammal species provides a simpler system for study. The wolves are the only predator of moose on Isle Royale, and their effect on the moose population is relatively easy to monitor and understand. Moose are essentially the only food for wolves, although beaver are significant at times. Finally and importantly, human impact is limited in the sense that people do not hunt wolves or moose or harvest the forest; the island provides an outstanding venue for ecosystem science.

The original purpose of the project was to better understand how wolves affect moose populations. The project began during the darkest hours for wolves in North America—humans had driven wolves to extinction in large portions of their former range. The hope was that knowledge about wolves would replace hateful myths and form the basis for a wiser relationship with wolves.

After six decades, the Isle Royale wolf-moose project continues. Today, wolves prosper again in several regions of North America. But our relationship with wolves in many parts of the world is still threatened by hatred, and now we face new questions, profound questions about how to live sustainably with nature. The project's purpose remains the same: to observe and understand the dynamic fluctuations of Isle Royale's wolves and moose, in the hope that such knowledge will inspire a new, flourishing relationship with nature.

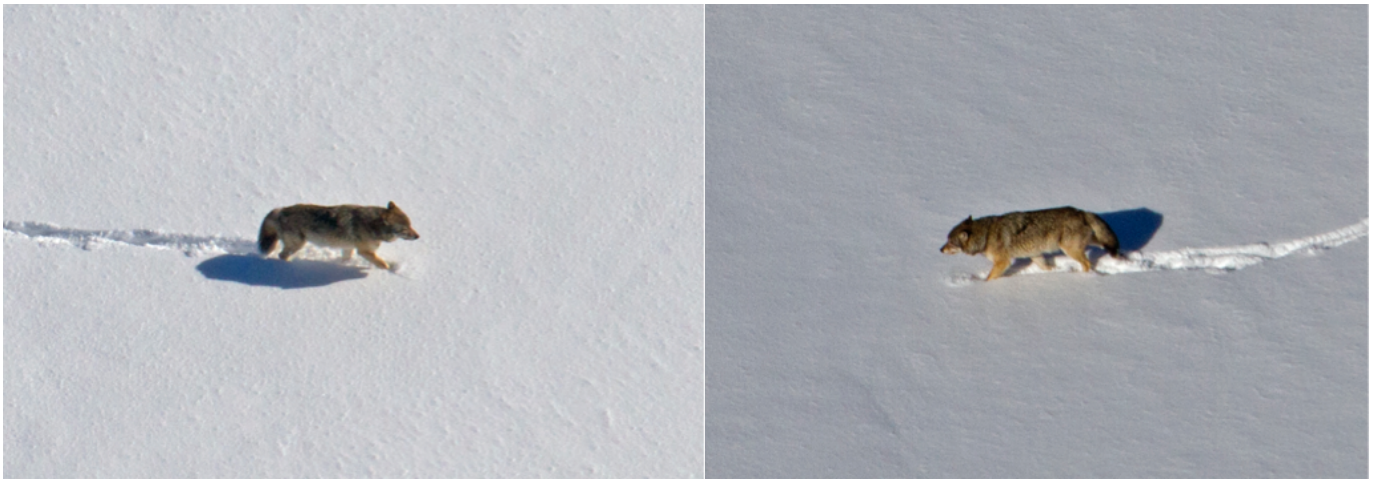
Many of the project's discoveries are documented at [www.isleroyalewolf.org](http://www.isleroyalewolf.org).

## Personnel and Logistics

In summer 2017, we conducted ground-based fieldwork from early May through mid-October. Rolf Peterson, John Vucetich and Sarah Hoy directed that fieldwork with assistance from Carolyn Peterson and Leah Vucetich. Summer interns Jennifer Cupp, Rylee Jensen, Laura Kwasnoski and Ben Wright did widespread field work on moose-balsam fir interactions. Leah Vucetich also led a number of people working in our lab, especially Brett Howland, Cheyanne Boucher, Tori Engler, Joellen Saugrich, and Joe Lazzari.

During the course of the year, many park staff and visitors contributed key observations and reports of wolf sightings and moose bones. Several dozen Moosewatch volunteers participated in week-long cross-country treks, searching for bones from moose.

In 2018, the annual Winter Study was conducted from January 16 to March 5, led by Rolf Peterson and Sarah Hoy. Ky and Lisa Koitzsch provided a solid month of daily field work on skis to collect data on moose and fir condition. Pilot Don L. Murray (UpNorth Aerials, Two Harbors, MN) piloted the primary research aircraft during 16 January - 5 February and 14 February - 3 March. Pilot Don E. Glaser provided a second aircraft during 29 January - 4 February. National Park Service staff Nathan Hanks and Lynette Potvin, from Isle Royale National Park, participated in the 2018 winter study. Bob Glaser, Lynette Potvin



**Figure 2.** In 2018 the two wolves remaining on Isle Royale were this father-daughter pair (who also shared the same mother, so they are half-siblings). The male (right) is nine years old and the female (left) is seven years old. Here they are shown on Anglemorm Lake on 22 February 2018.

(NPS), Bill Hance (NPS), and Mark Romanski (NPS) provided ground transportation on the mainland.

### The Wolf Population

On 20 January the wide-ranging tracks of the remaining two wolves (Figure 2) were followed through many frozen lakes at the east end of the island (Figure 3). The two wolves that remain on Isle Royale in 2018, not outfitted with radiocollars, are considered to be the two adults most recently identified by fecal DNA collected on 5 March 2015. They both originated in the Chippewa Harbor Pack, born to the same mother. The female is also the daughter of the male, so any offspring from this pair would be extremely inbred and probably non-viable.

The wolf pair was first observed on 14 February, probably having recently fed on a moose carcass. The pair traveled slowly across a beaver pond lined with wolf and fox tracks, the female leading the male and occasionally prodding him to rise when he lay down (Figure 4).

Next the pair were seen on 22 February on Anglemorm Lake, where they were feeding on another moose carcass of undetermined origin. Again the female was more active in initiating any activities, although the male was seen in a brief chase of a moose that traveled across the lake when only the male was watching (Figure 5).

### 2018 Wolf Travels and Kill Sites



**Figure 3.** During the winter study of 2018 the remaining two wolves continued to travel (thick gray line) throughout their usual territory at the east end of Isle Royale. They fed from two moose carcasses during 14 February - 2 March (triangles).



**Figure 4.** The two remaining wolves at Isle Royale remain a pair, even if they are not reproducing. In 2018 there was no evidence of any change in their status, except they are older by a year.

Finally, on 28 February the two wolves traveled over to Sargent Lake where they were observed sleeping in the warm sun much of the day.

An ice bridge formed between Isle Royale and the Ontario mainland during 2-9 February. We did not observe wolves traveling on the ice bridge, either coming from or going to the mainland. With apparently just two wolves present, there has been no wolf mortality or reproduction in the past three years. In 2017 the female clearly rejected courtship advances of the male. In 2018 we observed only one short interaction, consistent with previous behavior and suggesting the female would not accept the male as a mate.

On 16 March 2018 the NPS released its final environmental impact statement (EIS), which identified the NPS's preferred action would be to restore a viable wolf population by releasing 20-30 wolves over a three-year period. A final decision was pending at the publication of this report.

### **New insights on the fundamentals of inbreeding**

Inbreeding occurs when close relatives mate. Inbreeding also tends to be detrimental to the fitness of individuals organisms and populations. These detriments – referred to as inbreeding depression – can range from physical deformities to reduced reproductive vigor and shortened lifespan. Inbreeding is far more likely to happen in small populations already threatened with extinction. While there are plenty of insightful examples of inbreeding depression in wild populations, it remains difficult to study and there is much more to know about inbreeding depression.

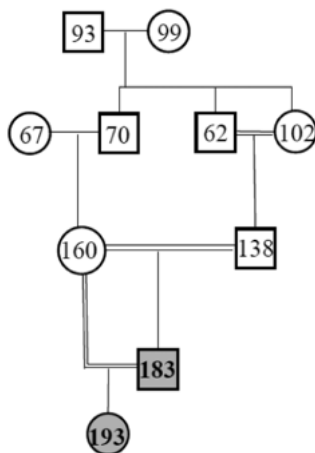
A basic obstacle to learning more about inbreeding depression in the wild is an ability to accurately and precisely quantify the degree of inbreeding in wild organisms. In service of quantifying inbreeding, for about the past century scientists have relied on a fundamental concept called the inbreeding coefficient, symbolized by the letter  $F$ , a number between 0 and 1. If you are not inbred in the least, then your inbreeding coefficient is  $F=0$ . If you are the most inbred you can possibly be, then your inbreeding coefficient is  $F=1$ . In technical jargon,  $F$  is the probability that two copies of an allele (one from each parent) are identical within an individual because they were passed down through a common ancestor at some time in the (not too distant) past.

Studying inbreeding depression in wild populations is rarely accomplished because it is so difficult to estimate  $F$ . For decades the best way to estimate  $F$  has been through a pedigree (Figure 6 gives an example). The problem is that it is so difficult to obtain a pedigree from a wild population. Doing so requires knowing everyone's parents and siblings. We have been doing that on Isle Royale for about 20 years now, but only through great effort – collecting hundreds of scats (source of fecal DNA) and spending hundreds of hours in the lab. For most populations it is simply not possible to obtain a pedigree.

In fact there is a second problem – in addition to the difficulty of estimating a pedigree: it turns out that pedigrees only provide an expected value of  $F$ . The true value of  $F$  can be different. For the most part no one bothered themselves with that detail, because



**Figure 5.** The only wolf-moose encounter observed in 2018 was a brief stand-off between the one remaining male wolf and a bull moose that wandered out on Anglworm Lake in direct view of the wolf. The wolf sprinted toward the moose, which became aggressive and then trotted away without any further contact as the wolf gave up the chase.



**Figure 6.** Pedigree showing the remaining 2 wolves, M183 and F193 (shaded) and their known ancestors, M93 (immigrant in 1997), F99 and F67 (native to Isle Royale). Double lines indicate matings between relatives, squares indicate males, and circles indicate females.

there was not a feasible means of doing any better. Not until now. Not until the work led by Phil Hedrick and Marty Kardos – both from Arizona State University.

Hedrick and Kardos studied in fine detail the level of inbreeding for the last two wolves in the Isle Royale population. These wolves are known to be extremely inbred. If they were to produce a pup his or her  $F$  would be 0.438. At least that's the estimate

according to the pedigree (Figure 6). Differences between  $F$  derived from a pedigree and the true value of  $F$  depend on some of the most basic properties of sexual reproduction – the number of chromosomes, the rate of recombination, and how far back in time the parents shared a common ancestor(s). Hedrick and Kardos took those factors into account, performed state-of-the-art genomics analysis on DNA samples from Isle Royale wolves, and were aided by the massive amount of information available from the dog genome. In doing so, Hedrick and Kardos determined that the true value of  $F$  could be anywhere between 0.311 to 0.565. It's the first estimate of its kind for wild organisms.

That's a pretty wide range and serves as a warning to conservation geneticists hoping that their estimates of  $F$  based on pedigrees are sufficiently reliable. In the future the analysis by Hedrick and Kardos will be more common. And when that is the case, we can thank the wolves of Isle Royale for helping to pave the way toward this new advance. For all the technical details see: Hedrick, P. W., Kardos, M., Peterson, R. O., & Vucetich, J. A. (2016). Genomic variation of inbreeding and ancestry in the remaining two Isle Royale wolves. *Journal of Heredity* 108, 120-126.

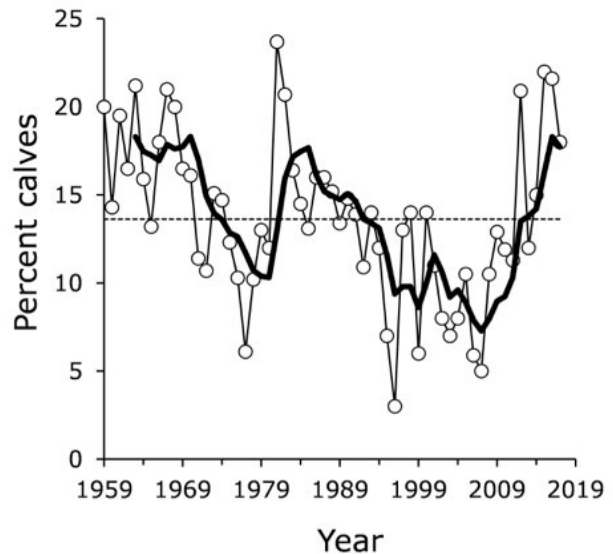


## The Moose Population

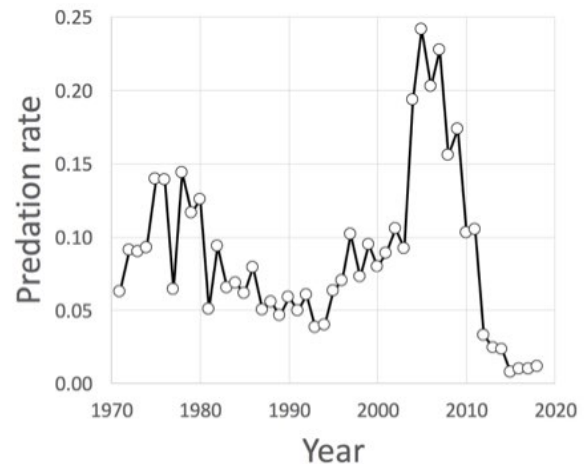
The 2018 moose survey began on January 28th and ended on February 18th. The survey resulted in an estimated abundance of 1475 moose. The 80% confidence intervals on this estimate are [1225, 1750], and the 90% confidence intervals are [1100, 1900]. Although there was considerable local variation in moose density, the best statistical model portrayed moose as relatively evenly distributed across the island, averaging 2.7 moose/km<sup>2</sup>. Overall counting conditions were similar to last year, with a strong snow crust. Crusted snow results in poor counting conditions because moose concentrate in habitats where the snow is less deep, typically coniferous stands. There moose are especially difficult to see from the plane, compared to more open habitats that they tend to occupy in the absence of crusted snow. Because these counting conditions were similar to last year, we used the same sightability correction factor as last year, i.e., 59%.

While this year's point estimate is lower than last year's point estimate, two lines of evidence suggest the moose population continues to grow. First, we observed 18% of the moose on census plots to be calves (Figure 7). Historically that level of calf production is associated with a growing population. Second, mortality rate of adults is unlikely to be higher than recruitment because the current age structure of the population is shifted toward young adult moose which have low intrinsic rates of mortality, moose forage is still relatively plentiful, and recent winters have not been especially severe. Aside from two dead moose that were fed on by wolves, we found only two additional dead moose, one that fell off a cliff and one that perished after falling on glare ice. Overall, moose mortality was negligible during the 2018 winter study (Figure 8).

The decline in point estimates between this year and last year (from 1600 to 1475) is readily attributable to statistical error associated with aerial based estimates of abundance: last year's estimate is plausibly an overestimate and this year's estimate is plausibly an underestimate. That possibility is reflected

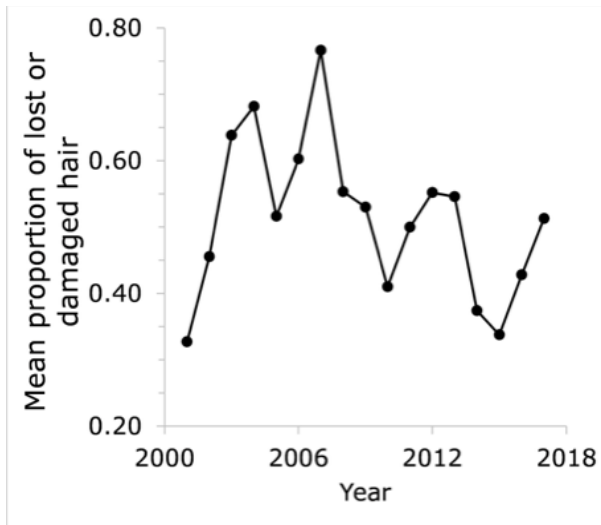


**Figure 7.** Long-term trends (1959–2018) in the percentage of the total moose population that are 8-month old calves. The 50-year average (13.6%) is marked by the dashed line, and the thick line is a 5-year moving average.



**Figure 8.** Predation rate (proportion of moose killed annually) has been low (<5%) for the past 7 years and negligible (~1%) for the past 4 years. The period of high predation rate (2003-2010) is associated with the fitness benefit of wolf genetic rescue that occurred in the late 1990s.

in the confidence intervals (CIs) associated with each estimate. These traditional CI estimates are based on analysis of sampling error. However, we were also able to estimate a narrower set of CIs (see Figure 1) using a new modeling approach (Gompertz state-space models) which incorporates uncertainty in



**Figure 9.** Photographs of moose in spring provide annual information on extent of hair loss caused by winter ticks (upper panel shows loss of hair due to ticks only on shoulders and neck, i.e., black areas). Hairloss extent in 2001-2017 has shown high inter-annual variation. (lower panel).

population counts arising from sampling error, but also with the ability to separate noise arising from biological processes (actual fluctuations in abundance) from sampling error (i.e. random over- and under-counting).

In last year’s annual report we indicated that the moose population has been growing at an estimated average rate of 21.6% per year, for the past six years. Adding this year’s estimate of abundance, the estimated average growth rate for the past seven years has been 16%. The true average rate of growth is likely in the range 16-22%. Even at the

lower range of growth (16%/yr) the population would double in four or five years.

For the past 17 years we have monitored the severity of winter tick infestation by photographing moose in spring, then digitizing each side profile and calculating proportion hair loss (Figure 9). Recent unpublished analyses suggest that weather variables and moose population density both influence hair-loss extent.

### The shrinking moose of Isle Royale

**BACKGROUND.** — The rapid rate of climate change raises concerns about how animal populations will cope. Moose – who are naturally creatures of the north – are an important example of such concern. They are important to the ecosystems to which they belong, and they are of great cultural value to the humans who live near them.

Moose have virtually disappeared from northwestern Minnesota. In the northeastern part of Minnesota moose now exist at only half the density seen a dozen years ago. This part of the world has also been experiencing rapid warming, especially during the winter. Warmer winters are tough for moose because moose are superbly adapted to tolerate the cold, but are susceptible to heat stress. According to some recent work, moose in Minnesota are more likely to die following warmer winters.

Some scientists have raised concerns about interpreting those patterns so simply. They wonder if warm winters are an insufficient explanation. They wonder if the declines are the result of a double whammy - the adverse impact of both warmer winters *and* parasites that spillover from white-tailed deer (brainworm, in particular). In addition, moose calf abundance may have been reduced by increased wolf predation.

The moose of Isle Royale National Park provide a useful comparison to moose in Minnesota. First, Isle Royale moose are not exposed to parasites that spillover from deer, because there are no deer on Isle Royale. Second, while Isle Royale and Minnesota share essentially the same climate, the moose population on Isle Royale has been growing at impressive rates as

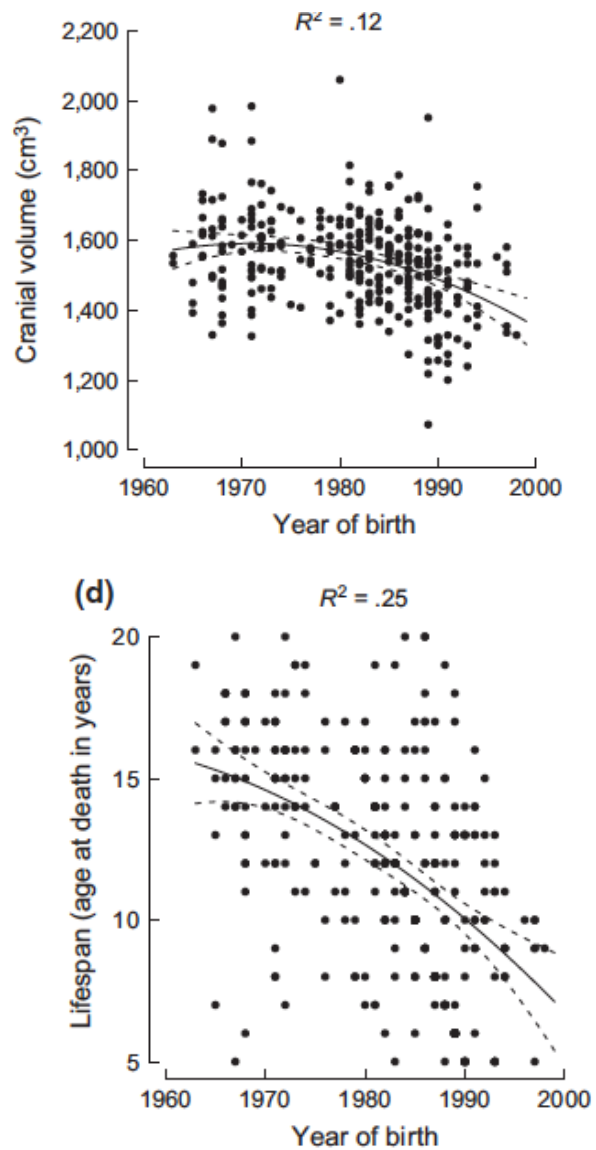
the moose in Minnesota have plummeted. As wolf predation collapsed after 2012, abundance of moose on Isle Royale has approximately tripled, facilitated by lack of parasitism and very low wolf predation.

**NEW INSIGHTS FROM ISLE ROYALE.** — Led by Sarah Hoy, we recently discovered some patterns in the moose of Isle Royale that have been slowly emerging over the past several decades. In a 2017 paper published in *Global Change Biology*, we demonstrated that moose who experience warm winters during their first year of life end up later in life with smaller skulls – an indication of smaller overall body size. We also found that skull size was smaller for moose born in years when moose were more abundant – because more moose means less food for each moose. Between 1960 and 2000, mean skull size has declined by 16% (Figure 10).

Approximately a fifth of that decline is attributable to climate and much of the rest was due to increasing density. That increase in density was largely due to the collapse of predation (Figures 8 & 11). It is widely known among moose biologists that smaller moose tend not to live as long. With that understanding, we looked at patterns in lifespan. During 1960-2000, mean lifespan has also declined, from around 15 years to less than 10 years. Again, part of the decline is attributable to climate and much of the rest was due to increasing density of moose. The results raise two intriguing questions.

First, how can the moose of Isle Royale be impacted in those two basic ways – skull size and life span – yet population abundance is high? A plausible answer is: We are observing a period of transition. First, in previous decades we have documented a decline in mean lifespan that is linked, in part, to warmer winters. And in the future this influence might grow and be reflected in the population dynamics. A second plausible answer is that moose are making up the difference caused by warmer winters through some other, as yet, unappreciated aspect of their life history.

The second intriguing question stems from climate warming also being responsible for driving



**Figure 10.** Extensive collections of moose skulls over four decades revealed that moose body size and lifespan have both declined. Both graphs illustrate results for female moose.

wolves on Isle Royale to the brink of extinction. The question raised by this new research is: if there is a risk that moose are destined to suffer from climate warming to the point of collapse, then does it still make sense to restore wolf predation?

That concern had been raised before (Gostomski 2013, *The George Wright Forum*). The response to that concern is: If restoration of predation is important for maintaining Isle Royale’s ecosystem

health today, then it would be unwise to refrain from such restoration just because “climate change might threaten the viability of their prey at some indefinite time in the future.” (Vucetich et al. 2013, *The George Wright Forum*) This circumstance would seem to be accommodated by the NPS’s recommendation, because their EIS is framed by a timetable covering only the next 20 years.

Moreover, much of the decline in skull size and lifespan of Isle Royale moose has been attributable to increased moose density, which resulted from the failure of predation.

## Vegetation

**TERRESTRIAL.** — Across Isle Royale balsam fir has declined about 75% since 1846, reduced from 36% in the original land survey to 9% in 2010 (U.S. Forest Service data). Moose browsing is the primary driver of this decline on the west end of Isle Royale. Under the dense hardwood canopy of the western half of the

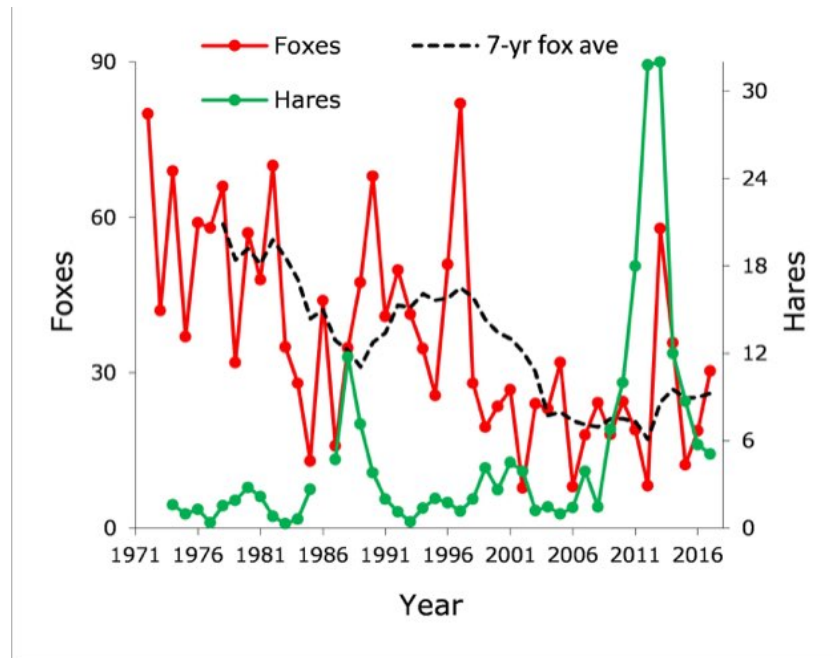


**Figure 11.** This was an unusual congregation of a dozen moose during February 2018 in an area at the west end of the island where balsam fir had been recovering from decades of moose herbivory.

island, where fir is further limited by light and germination sites, moose browsing largely eliminated growth of regenerating fir trees in the past 100 years. In the absence of regeneration, balsam fir would eventually disappear. In fact, over 90% of a sample of west-end fir trees tagged in 1988 have now died without replacement by new fir. In the late 2000s, quite unexpectedly, long-suppressed fir saplings at the west end of the island, often decades-old but still less than a meter tall, began to grow because browsing by moose was reduced. The moose population was reduced because wolves, buoyed by genetic rescue a decade earlier, preyed on moose at a higher level than previously seen on Isle Royale (Figure 8).

The future status of balsam fir on the western half of Isle Royale is critically dependent on the growth and survival of new regenerating trees, as most seed trees have already disappeared. By 2017, there were more than 500 fir trees newly-released from herbivory in a trail transect approximately seven miles in length (representing a 10-ha area) where 479 mature trees existed in 1988, a hopeful sign of possible recovery. Provided they are not killed or suppressed by moose browsing, these emerging stems represent potential recruitment of mature trees in the future that could replace those that have largely died out. As of 2017, the number of emerging trees continued to increase, in spite of browsing pressure from an increasing moose population. The outcome of this survival contest, trees versus moose, will plausibly depend on the pace and outcome of proposed restoration of wolf predation.

**AQUATIC.** — While it has long been known that moose are prodigious underwater foragers, determining the impacts of moose on aquatic plants continues to be an important research challenge. In the past decade, a native floating-leafed plant called watershield (*Brasenia schreberi*) provided some insights on how moose feeding affects aquatic communities. Watershield, a plant that can quickly grow over much of the water surface of ponds and shallow lakes, is highly favored by both moose and beaver. In the late 2000s, when moose were reduced by wolf predation,



**Figure 12.** Indices of abundance for red foxes and snowshoe hares on Isle Royale, 1974-2018. The hare index is the number of hares observed per 100 km of summer hiking. The fox index is the number of foxes seen from the survey aircraft during Winter Study, the sum of the maximum number seen at kills plus the number seen otherwise per 100 hours flight time. The dashed line is a moving average, highlighting a long-term trend in fox abundance.

watershield emerged from obscurity to become the dominant aquatic plant in five ponds at the east end of Isle Royale, covering as much as 90% of the water surface. Moose discovered this new resource and they increasingly congregated in ponds to feed on watershield. During 2012-2017 we determined surface coverage of this plant using photos taken from aircraft and satellite. By 2017, after intensive feeding by moose in spring and early summer, watershield coverage was reduced to essentially zero by August. This is only one of many impacts of moose on aquatic areas, but one that is readily measured.

### Other Wildlife

During winter 2018 tracks of marten were observed at Windigo and several other nearby locations, and marten were observed twice. Since 1991 marten sign has been observed in all but three years, while sign was completely absent during 1959-1990. Regarding other small mustelids, in the past year tracks of short-

tailed weasel were recorded once, but no signs of American mink were seen.

Interactions between snowshoe hares and their predators have fascinated ecologists for many decades, and research in other locations has revealed a complex picture of how predation, weather and food supply interact to produce roughly decadal fluctuations in hare numbers, at least when lynx are present. Predator populations then typically peak and decline in rough synchrony with their prey. In any single location, such as Isle Royale, there are factors that modulate this pattern. For Isle Royale, given only imperfect indicators of abundance for snowshoe hares and red foxes, a primary predator species, we can only speculate that competition with moose, severe winter weather, and predation may all be factors that influence hare density (Figure 12). All three factors may have been minimized during the exceptional peak in hare numbers in 2012-2013. We could also note that great-horned owls, the other primary predator of hares, seemed to have been relatively abundant during



**Figure 13.** Ravens, eagles, and red foxes are prominent scavengers of dead moose on Isle Royale, and without kills provided by wolves the populations of these species have likely diminished. Bird species may simply leave for the mainland, but resident foxes probably have to increasingly rely on other food sources.

the recent surge in hare numbers, with multiple pairs nesting in the Rock Harbor channel alone.

One snowy owl was observed on Isle Royale in February 2018, coincident with an unusually high number of observations of snowy owls on the mainland this winter.

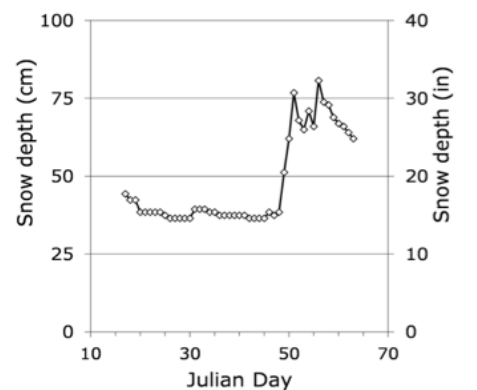
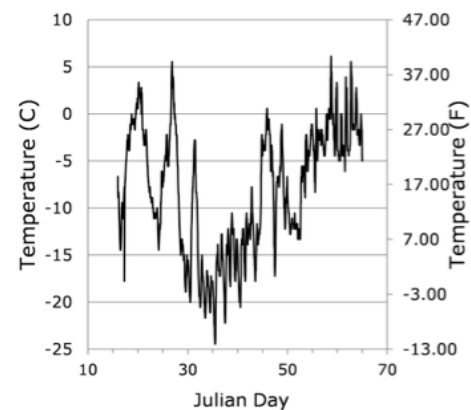
Active beaver colonies have been counted on Isle Royale about every other year since 1964. The next aerial survey of beaver colonies is scheduled for October 2018.

In 2017 trumpeter swans nested (first record) on at least two lakes on Isle Royale, and in one case three cygnets were produced (no data on the other nesting).

## Weather, Climate, and Ice

Consistent with a La Nina winter in North America, at Isle Royale temperature and snow depth were near average during winter 2016-2017, with freeze-up of interior lakes and protected bays of Lake Superior occurring in December. There were two major thawing events during the Winter Study before seasonal warmup began in late February (Figure 14). Mild crusts provided inconsistent support for wolves and, together with deep snow, resulted in moose shifting to coniferous cover for most of the Winter Study. Several days of cold temperatures and light winds in early February produced considerable ice on Lake Superior, resulting in an ice bridge between Isle Royale

and the mainland to the north during 2-9 February. We did not detect any wolf movement on this ice bridge, and the island wolf count was unchanged after the ice bridge disappeared.



**Figure 14.** Ambient temperature (one-hour intervals, top graph) and snow depth (daily, bottom graph) during the 2018 Winter Study on Isle Royale.



"The introduction of wolves would restore the ecological function of predation to the island and support the natural quality of wilderness."

— National Park Service, Environmental Impact Statement  
to Address the Presence of Wolves, 2018, P. C-32.





Tax-deductible donations to support continuing research on Isle Royale wolves and moose can be sent to

Wolf-Moose Study  
Michigan Tech Fund  
Michigan Technological University  
1400 Townsend Drive  
Houghton, MI 49931-1295

THANK YOU to all who help!



800 East Lakeshore Drive  
Houghton, MI 49931-1869  
800-678-6925  
[www.irkpa.org](http://www.irkpa.org)



**Michigan  
Technological  
University**